

Campaña de recolección

Concientizadas



De 7:30 am a 3:00 pm



Parqueo Centro de las Artes

Lo que **SÍ** y lo que **NO** recibimos de



Reciclables



Electrónicos



Vidrio



Medicamentos



Aceite

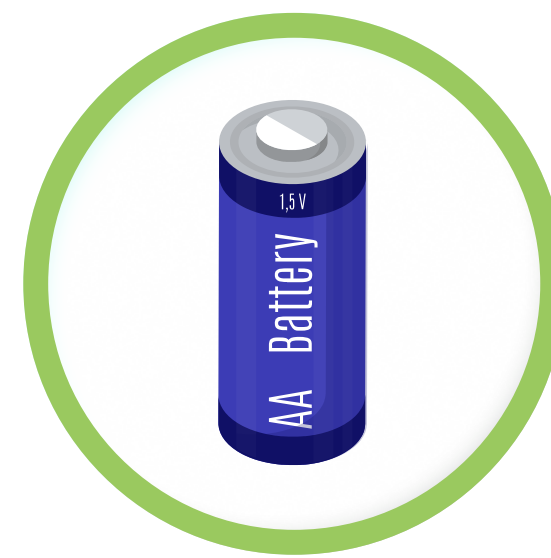

Baterías

Concientizadas

Lo que **SÍ** y lo que **NO** recibimos de
residuos reciclables

Podés ganar **ecoins**



Reciclables: lo que **sí** recibimos

Plásticos



Botellas plásticas
(plástico 1 y 2)



Bolsas plásticas
(plástico 4)



Aluminio



Tetra Pak



Papel y Cartón

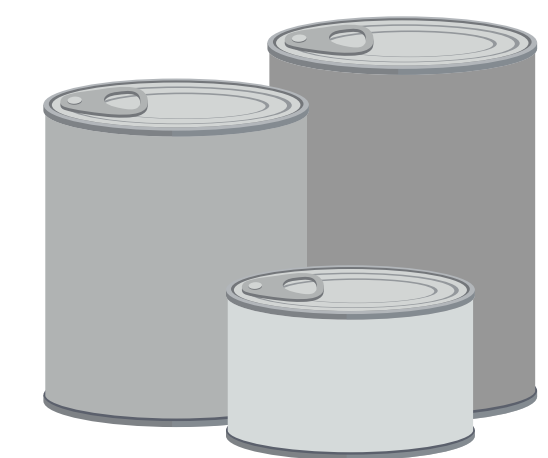

Hojalata



Vidrio

Reciclables: lo que **NO** recibimos

Plásticos

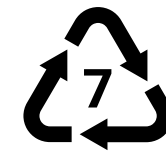
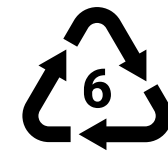

Vajillas desechables de plástico o papel/cartón



Juguetes



CDs



Papel aluminio



Cartón de huevo



Aerosoles

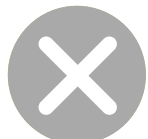

Papel y cartón sucios/mojados

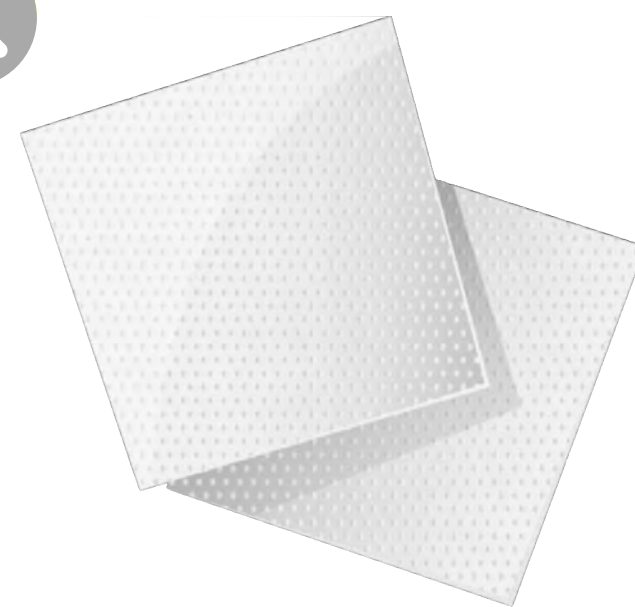

Servilletas



Envases para almacenar comida, empaques no metalizados (plástico 5)

Concientizadas

Lo que **SÍ** y lo que **NO** recibimos

+ intercambio de

vidrio

Podés ganar **ecoins**



Vidrio: lo que SÍ recibimos



Botellas



Frascos



Vasos y platos
(no de cerámica ni
de porcelana)

Intercambio



Se regalarán vasos de vidrio por
cada 3 kg de vidrio entregado

Vidrio: lo que NO recibimos



Loza (vajilla de cerámica o porcelana)



Pyrex



Espejo



Bombillos



Ventana



Cristalería de laboratorio

Concientizadas

Lo que **SÍ** y lo que **NO** recibimos de
residuos electrónicos

Podés ganar **ecoins**



Electrónicos: lo que SÍ recibimos



CPU y UPS



Teclados y mouse

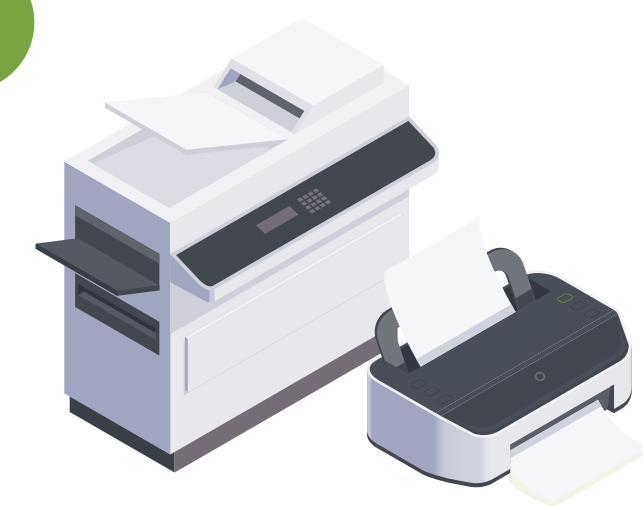

Impresoras, scanners,
fotocopiadores y fax



Laptops

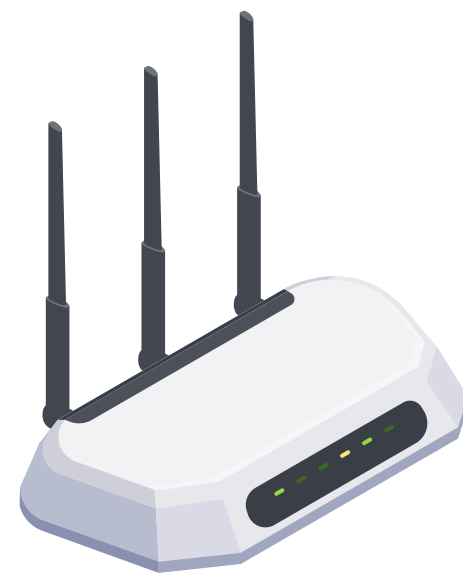

Router

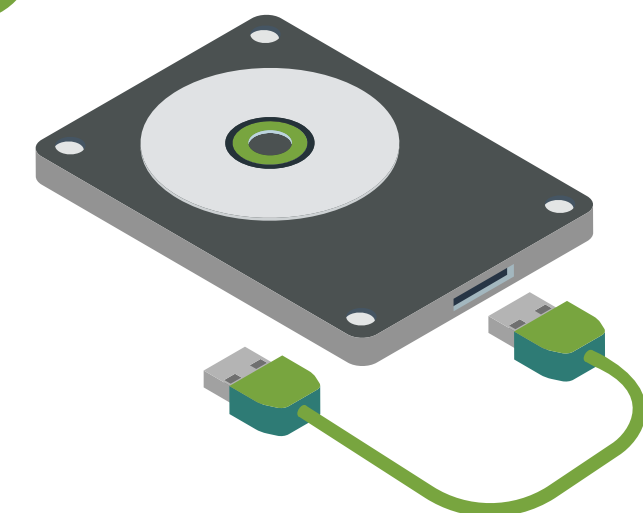

Discos duros



Pantallas planas

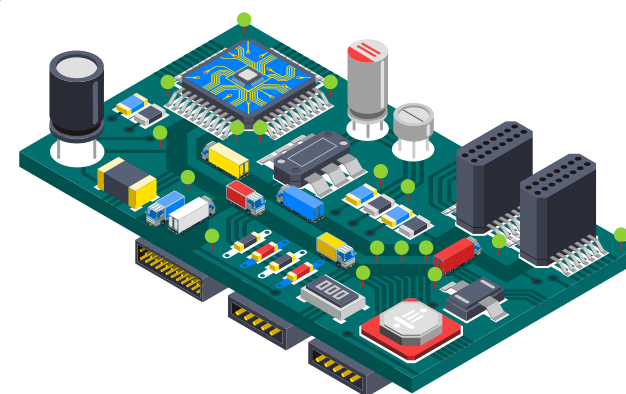

Tarjetas
electrónicas



Electrodomésticos
pequeños

Electrónicos: lo que SÍ recibimos



Lavadoras o
secadoras

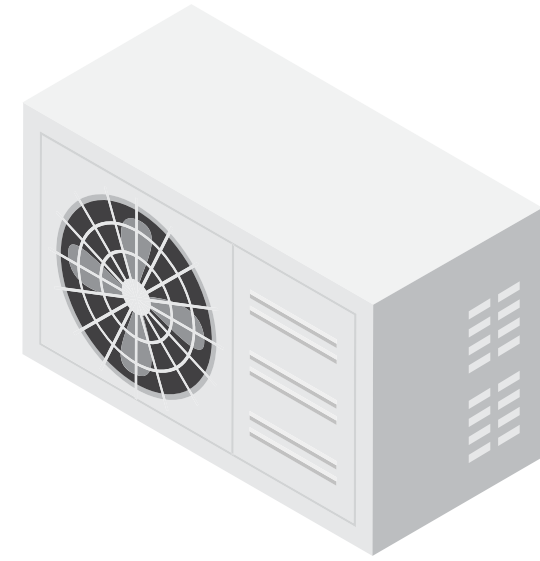

Aire acondicionado



Lavaplatos



Tablets

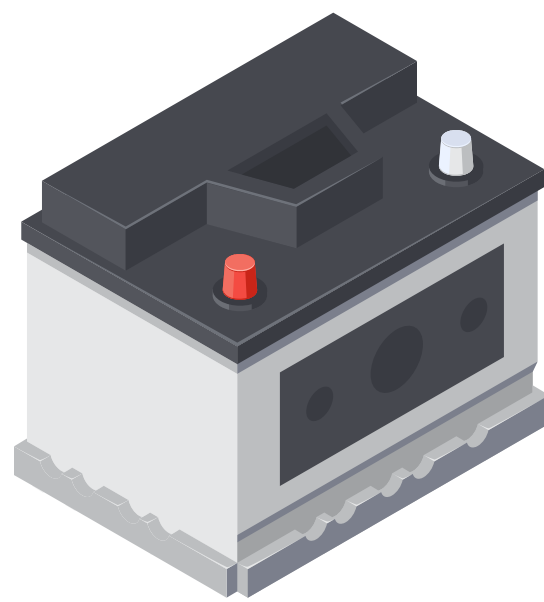

Fuentes de poder



Microondas



Cocinas



Celulares



Switch metálico

Electrónicos: lo que NO recibimos



Iluminarias LED

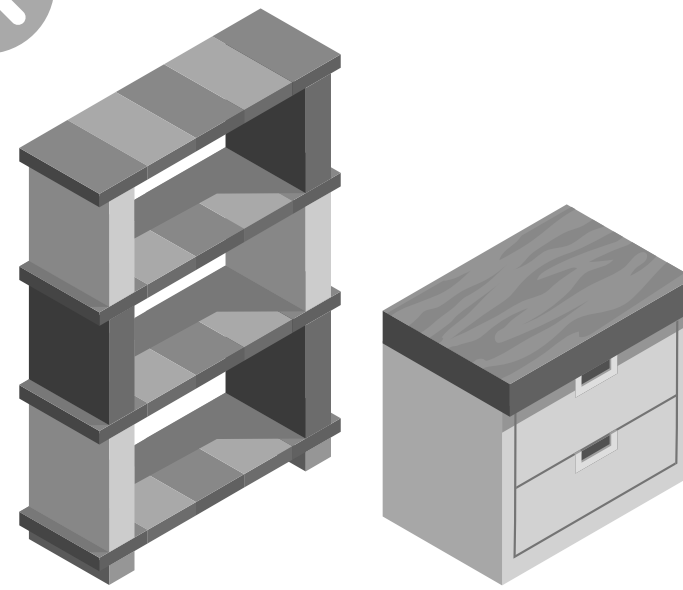

Muebles

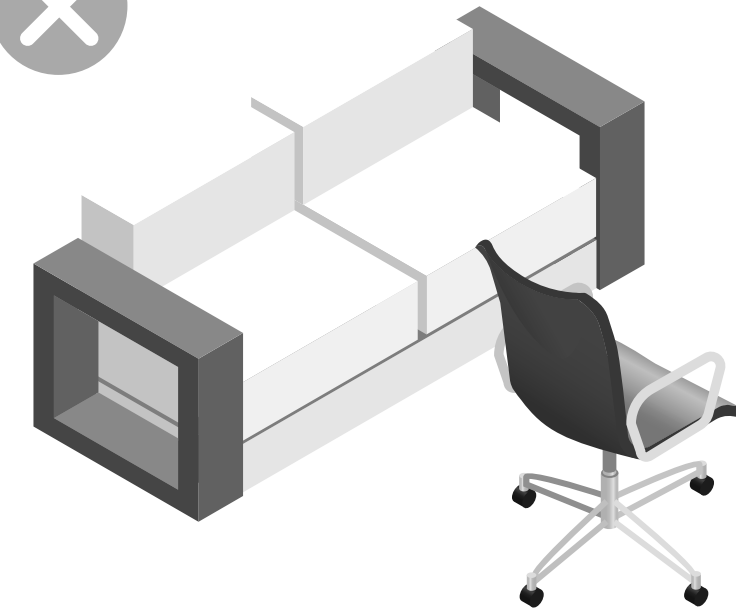

Sillas y sillones

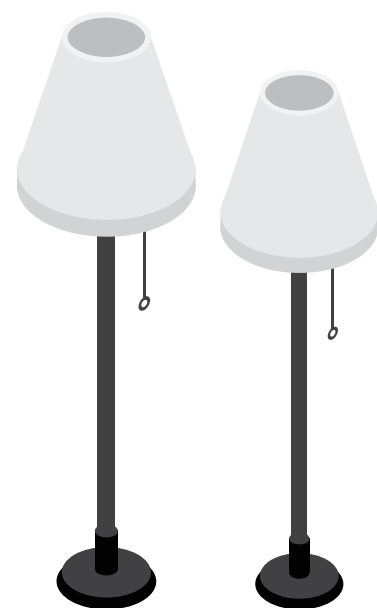

Luminarias

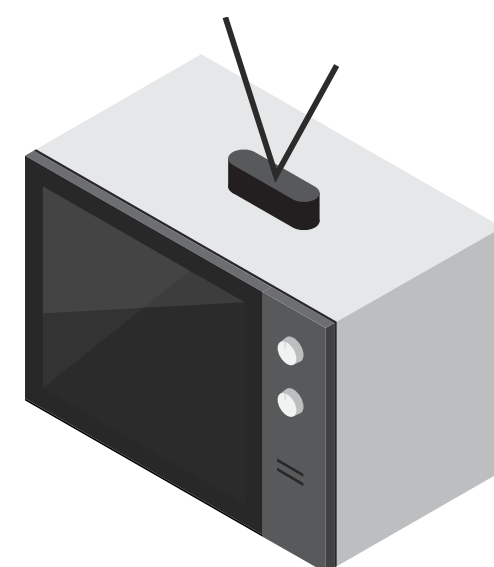

TVs viejos

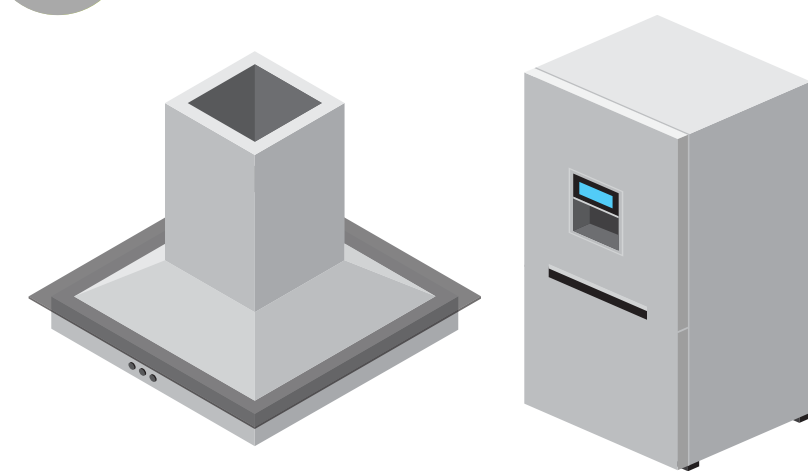

Extractor de grasa
y refrigeradoras



Fluorescentes

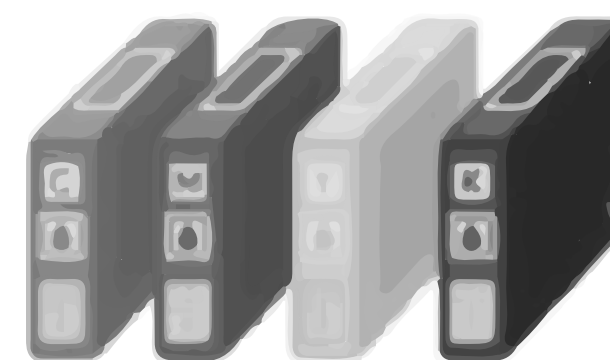

Cartuchos de
tóner y tintas

Concientizadas

Pasos para separar el aceite de cocina usado

Podés ganar **ecoins**



Aceite de cocina usado:

pasos para reciclarlo



En un recipiente
limpio, seco y con tapa.

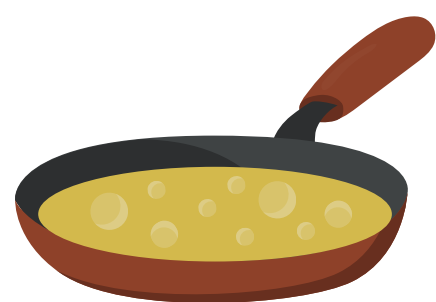

Dejá enfriar el aceite
antes de almacenarlo
en el recipiente.



Colarlo
para eliminar los restos
de comida



Debe verse el contenido
del recipiente.
Se puede mezclar con
aceite de latas de atún.



No mezclar el aceite
con agua ni con
restos de comida.

Concientizadas

Lo que **SÍ** recibimos de
baterías



GASEL
GESTIÓN AMBIENTAL

TEC

Panasonic

Baterías

unicamente se reciben de la marca:



Panasonic



Se revisará la marca de cada batería,
serán devueltas las que no cumplan.

Concientizadas

Lo que **SÍ** y lo que **NO** recibimos
medicamentos

Podés ganar **ecoins**

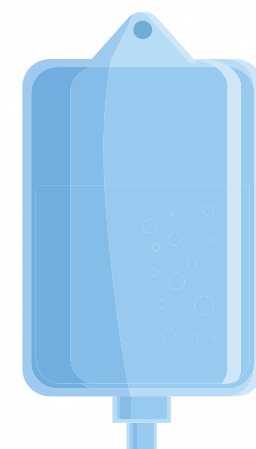

Medicamentos: lo que SÍ recibimos

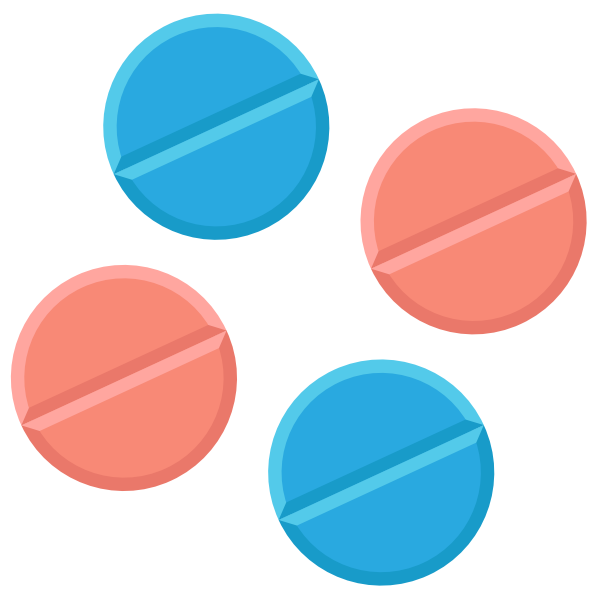

Tabletas*



Cápsulas*

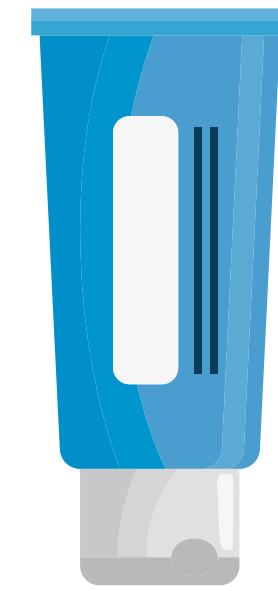

Cremas*

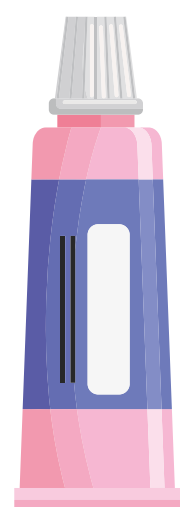

Geles*

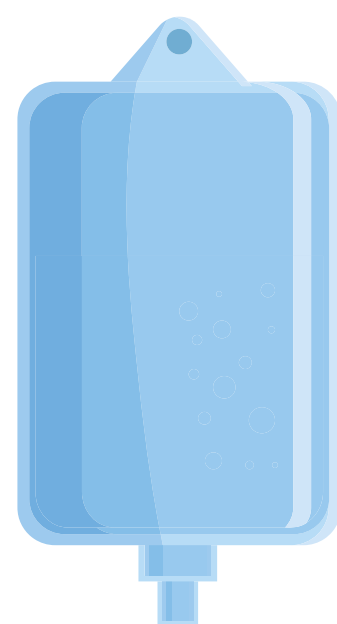

Soluciones*



Empaques o
envases
vacíos que hayan
tenido contacto con
el medicamento

* vencidos, deteriorados o en desuso

Medicamentos: lo que NO recibimos



Agujas, lancetas
o jeringas

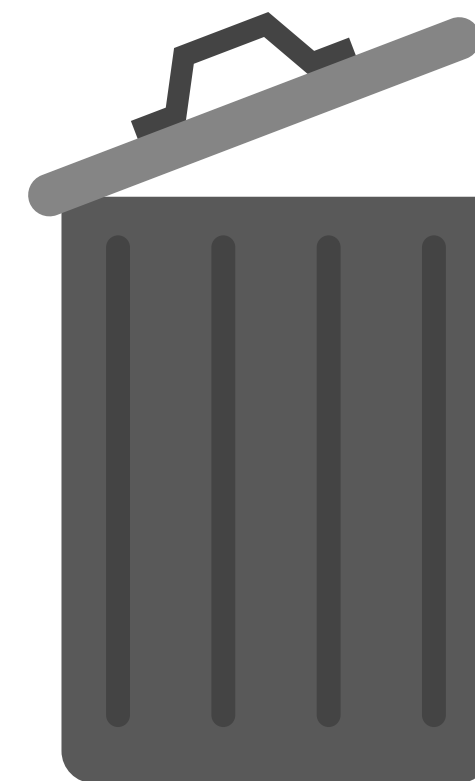

Residuos comunes que
deben ir en los cestos de
basura común